



PROFESSIONAL

# Cafitesse Excellence Touch

Operator Manual

EXCELLENCE TOUCH - 2020-10



Copyright 2020 © JACOBS DOUWE EGBERTS, the Netherlands  
The English version is the original version of the operator manual.  
Other languages are translations of the original operator manual.

Manufacturer:  
EVOCA SpA  
Via Roma 24  
24030 Valbrembo (BG)  
Italy

# TABLE OF CONTENTS

- 1 - PREFACE . . . . . 4**
  - About the dispenser . . . . . 4
  - Important . . . . . 4
  - Symbols used in this manual . . . . . 4
- 2 - SAFETY INSTRUCTIONS. . . . . 5**
  - General safety . . . . . 5
  - Transport and storage . . . . . 6
  - Installation . . . . . 6
  - Specific safety for Marine application . . . . . 7
  - Food safety instructions (HACCP) . . . . . 8
  - Training . . . . . 8
- 3 - OVERVIEW . . . . . 9**
  - Dispenser overview . . . . . 9
  - Dispenser interface overview . . . . . 10
  - Status Line . . . . . 11
- 4 - OPERATING. . . . .12**
  - Placing a product pack . . . . . 12
  - Empty product packs . . . . . 12
  - Cup/pot placement . . . . . 13
  - Drink delivery . . . . . 13
  - Switching off the dispenser . . . . . 18
  - Switching on the dispenser . . . . . 18
  - Various Settings and Information . . . . . 19
- 5 - CLEANING . . . . .20**
  - Exterior cleaning . . . . . 20
  - Cleaning procedures . . . . . 20
  - When to clean the dispenser . . . . . 21
  - Flushing . . . . . 21

- Complete cleaning . . . . . 23
- 6 - PROGRAMMING . . . . .26**
  - Introduction . . . . . 26
  - Access the Operator Menus . . . . . 26
  - Programming Home Menu . . . . . 27
  - Entering the Values . . . . . 29
  - Daily Action (menu section 1) . . . . . 30
  - Drinks Settings (menu section 2) . . . . . 31
  - Machine Settings (menu section 3) . . . . . 36
  - Drink counters / Statistics (menu section 4) . . . . . 40
  - Energy Saving (menu section 5) . . . . . 43
  - Payment Systems (menu section 6) . . . . . 45
  - System (menu section 8) . . . . . 45
- 7 - PAYMENT SYSTEMS . . . . .46**
  - Introduction . . . . . 46
  - Various payment functions . . . . . 46
  - Prices (menu section 6) . . . . . 47
  - Payment system protocols (menu section 7) . . . . . 49
- 8 - TROUBLESHOOTING. . . . .55**
- 9 - SPECIFICATIONS . . . . .57**
- APPENDIX A - INTERNATIONAL LISTING OF POWER PLUGS . . .59**

# 1 - PREFACE

## *About the dispenser*

Thank you for choosing the Cafitesse Excellence Touch dispenser. The Cafitesse Excellence Touch is a high quality dispenser specifically designed to deliver hot and cold\* coffee, coffee based specialties, cocoa drinks (option) and hot water for the professional food service industry.

This manual contains comprehensive operating and safety instructions. Please operate and maintain the dispenser as described in this manual for the best dispenser performance and to comply with food safety regulations / HACCP.

In case of questions, please contact your Cafitesse system supplier.

## *Important*

The dispenser is only to be installed in locations where it can be overseen by trained persons.

Operation, filling and cleaning of the dispenser must be restricted to authorized and trained persons. Ensure that new staff members read the operator manual before they operate the dispenser, and understand the safety and hygiene aspects.

The manufacturer and JACOBS DOUWE EGBERTS cannot be held liable in case of damage and/or injury resulting from improper operation of the dispenser or from non-compliance with the procedures given in this manual.

## *Symbols used in this manual*

The following symbols are used throughout this manual in combination with a statement to emphasize important and critical information. Observe the statements to ensure safety and prevent injury and product damage.



### **Note:**

Gives additional information which may be helpful during the dispenser operation.



### **Caution:**

Alerts against unsafe practices. Observe to ensure food safety, to prevent minor personal injury, or damage to the dispenser.



### **Warning:**

Indicates a potentially hazardous situation which, if not avoided, could result in serious injury and even death.



### **Danger:**

**INDICATES A IMMINENTLY HAZARDOUS SITUATION WHICH, IF NOT AVOIDED, WILL RESULT IN SERIOUS INJURY AND EVEN DEATH.**

## 2 - SAFETY INSTRUCTIONS

### *General safety*

The equipment is not intended for use by persons (including children) with limited psychological or physical abilities or deficiencies. To warrant their safety, they should be supervised and instructed by a competent person regarding the usage of the equipment.

 **Danger:**  
**NEVER TOUCH THE POWER SUPPLY PLUG WHEN YOUR HANDS OR THE POWER CORD / PLUG ARE WET.**

 **Warning:**  
Do not leave children unattended near the dispenser.

 **Warning:**  
If the power cord of the dispenser is damaged, switch off the dispenser and contact your system supplier for replacement.

 **Warning:**  
The products delivered by the dispenser are very hot! In order to prevent scalds, keep your hands and other parts of the body away from the delivery area when a delivery takes place or during flushing (cleaning of the dispenser).

 **Warning:**  
Do not place cups, pots, or containers filled with hot liquids on top of the dispenser.

 **Warning:**  
There is the risk of being scalded, in case the cups/pots/containers fall down.

 **Warning:**  
Keep sufficient space around the dispenser to get away easily in case of hot liquid splashes.

 **Warning:**  
Place the dispenser on a table or counter with a minimum height of 60 cm/24 in to avoid that young children can start a drink delivery.

 **Caution:**  
Check and empty the drip tray of the dispenser regularly to avoid the risk of being scalded and to avoid a wet floor (slip danger) when (hot) liquids spill out of the drip tray.

 **Warning:**  
Only use original spare parts for the operation of the dispenser.

## ***Transport and storage***

Always store and transport the dispenser in the original packaging.

Before storing or transporting the dispenser:

- Place the product packs in the refrigerator.
- Clean the dispenser.
- Contact your Cafitesse system supplier so that an authorized and trained service technician can drain the water from the boiler and protect the dispenser against frost damage.



### ***Caution:***

The dispenser may not be subject to frost during operation, storage or transport.

## ***Installation***

Installation, relocation, service and programming of the dispenser is restricted to authorized and trained service technicians.

The equipment must be installed by your Cafitesse system supplier in compliance with the installation requirements:

- The dispenser is designed for indoor installation only, place it on a stable flat surface such as a table or a counter capable of supporting its weight. Shield the dispenser from direct sunlight, frost and rain.
- Make sure that there is sufficient space around the dispenser for ventilation, and front/back sides are accessible for service.
- Only use new water hoses and connections in compliance with EN61770 for connection to the water supply, old and/or used water hoses are not allowed.
- The dispenser must be connected to the drinking water line in compliance with local regulations. In case of cold drink options, the quality of the water supply must be checked to ensure delivery of safe cold drinks according to local regulations.
- Shield the dispenser from running water, splashes, spray or steam, heat or heavy dust.
- The dispenser may not be cleaned using a water jet and is not suitable for installation on a surface, where a water jet may be used in the vicinity (e.g. for cleaning purposes).
- If the dispenser is connected with a permanently wired power supply (without mains plug), ensure the electric circuit is equipped with a circuit breaker with a contact opening of at least 3 mm / 0.12 in that controls all poles.
- If connected to a wall outlet power supply, use a grounded safety plug socket in compliance with local regulations. Ensure that the electric circuit is secured by means of a fault current safety switch and that the power supply plug remains accessible after installation.
- The power supply plug may only be replaced by authorized and trained service technicians. The same model of plug or one of the models listed in appendix "A" has to be used for the replacement.
- The manufacturer disclaims all responsibility for any damage caused by the non-observance of the safety instructions mentioned above.

## *Specific safety for Marine application*

 **Warning:**  
Excellence dispensers, which are equipped with the related (fixation) kits, have been tested according to the safety standards with aggregated conditions of inclination = 22.5° AND oscillation frequency up to 0.1Hz AND for a timing up to 15 minutes for each direction.

 **Warning:**  
If the tilting conditions are outside the limits defined from the safety test, please switch off the dispenser and ensure no hazard can occur to persons and things in the proximity of the dispenser by taking additional fixation measures.

 **Warning:**  
Check the correct and secure fixation of all screws, torque (min. 6,5 Nm max. 8 Nm) or marks due to reciprocal movements frequently during the normal maintenance.

 **Warning:**  
In case of rough sea, check the correct and secure fixation of all screws, torque (min. 6,5 Nm max. 8 Nm) or marks due to reciprocal movements after each event or each day during the event.

 **Warning:**  
Slope of the drainhose should be in such a way the water can be drained properly.

 **Warning:**  
For valid NSF approval, the sticker(s) showing the NSF mark together with manufacturer's name, product name and number must not be removed from the part (if it's present).

### ***Food safety instructions (HACCP)***

The dispenser is designed to comply with food safety regulations, including HACCP, as required in the food service industry. The operator is responsible to observe basic food safety and hygiene. Observe the cleaning procedures given in this manual. Please note that HACCP regulations require that these are recorded.

- Follow the instructions printed on the Cafitesse product packs regarding storage and handling.
- Wash hands when handling product packs or dispenser parts that come in contact with ingredients.
- Do not touch the tip of the doser. If the doser needs cleaning, rinse with clear water only.
- Observe the "Best before" and "Expiry" dates on the product pack. Do not use a product pack if either date has expired and use the packs that has been stored for the longest period first (first-in, first-out principle).
- Keep the area around the dispenser clean and tidy.
- Only use cleaning agents recommended by the food industry and your Cafitesse system supplier. For safe handling observe the instructions on the label of the cleaning agent.



*Danger:*

**DO NOT SPRAY OR SPLASH THE DISPENSER WITH WATER.  
DO NOT USE A WATER JET FOR CLEANING.**



*Danger:*

**NEVER TILT THE DISPENSER TO CLEAN BEHIND OR BELOW IT. AVOID SCALDING!  
THE BOILER CONTAINS VERY HOT WATER THAT CAN SPILL OUT IF YOU TILT OR MOVE THE DISPENSER.**

### ***Training***

Train new staff regarding food safety instructions (HACCP).

- Inform new staff about schedules and cleaning procedures.
- Ensure that new staff reads the operator manual before operating the dispenser.
- Keep the operator manual close to the dispenser.

If there are any questions, please contact your Cafitesse system supplier.



# 3 - OVERVIEW

## Dispenser overview

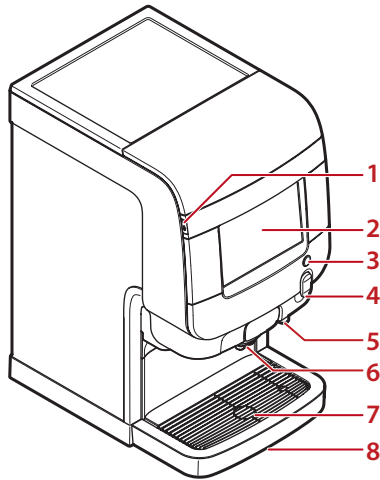

1. Connector for USB-key
2. Touch screen
3. Hot water button for free flow delivery
4. Door handle (*lock optional*)
5. Right outlet for hot water
6. Center outlet for drinks
7. Cup tray
8. Drip tray

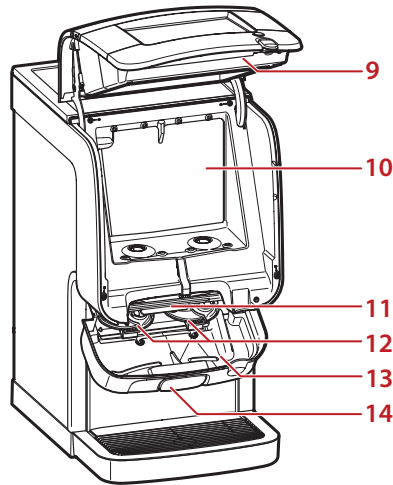

9. Dispenser door
10. Cooling compartment
11. Release bar
12. Mixing bowls
13. Internal drip tray
14. Outlet compartment

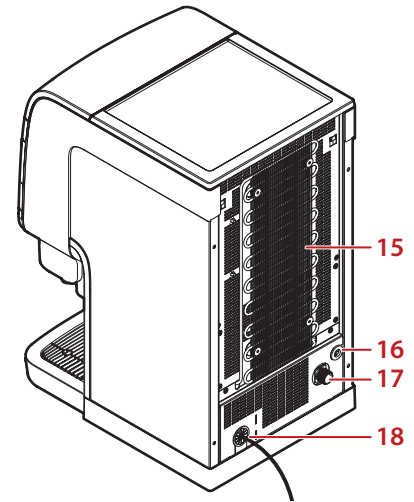

15. Condensate grid
16. Connection for options
17. Water connection
18. Power cord

## Dispenser interface overview

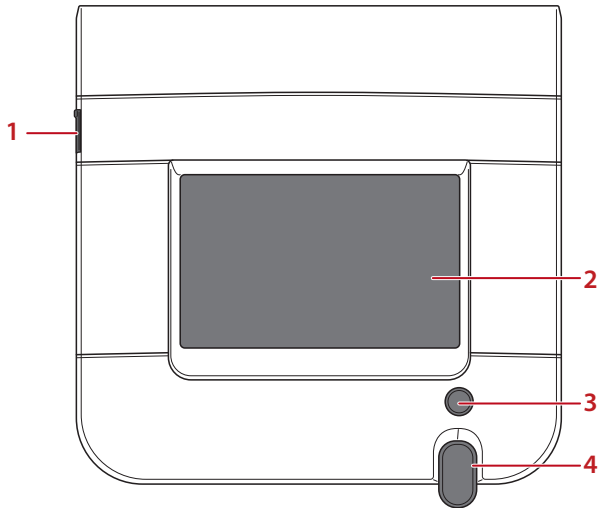

1. Connector for USB-key
2. Touch screen
3. Hot water button for free flow delivery
4. Door handle (*lock optional*)

For drink delivery, cleaning, and programming use the following finger operations on the touch screen, please find samples in the operating instructions:

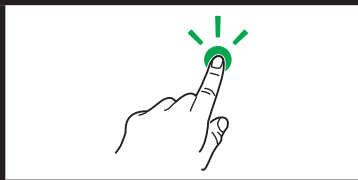
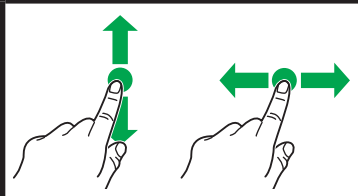
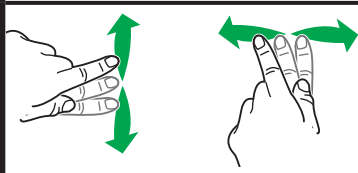
	Tap on icons, features, and objects to activate them, or open context menus.
	Touch and hold icons and objects and move or drag them to another position.
	Slide the finger on the touch screen up/down/left/right to scroll through menus and values.

## Status Line

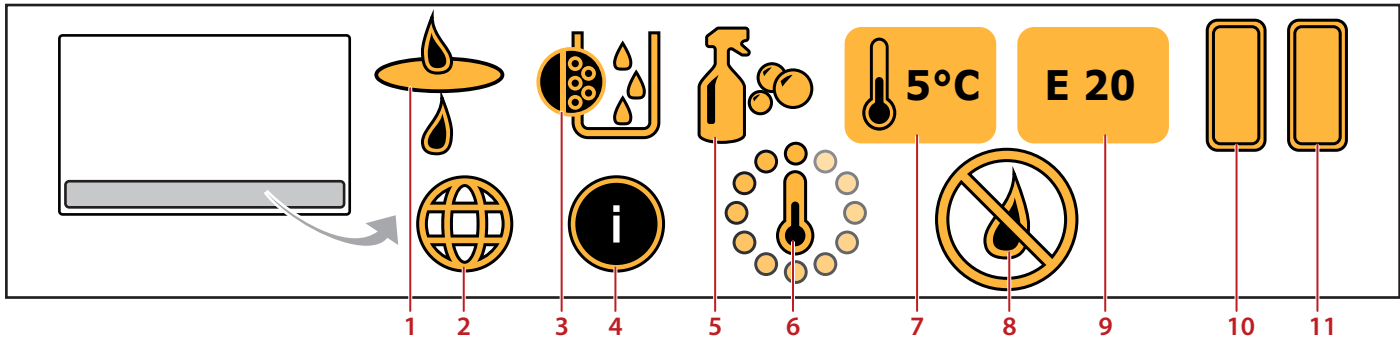

Depending on the status of the dispenser, the status line can show the following icons:

1. **WATER FILTER** alarm - replace the water filter
2. **SPECIFY COUNTRY** - select language and currency, e.g. for payment systems
3. **DESCALING** alarm - decalcify the boiler
4. **NUTRITION FACTS** - displays food information about the drink
5. **CLEANING** alarm - operate the cleaning procedure
6. **BOILER HEATING** - water in the boiler is heated up
7. Display of the **TEMPERATURE COOLING COMPARTMENT**
8. **NO WATER / NO DRINK DELIVERY**
9. Display of the **ERROR CODES**, see chapter „8. Troubleshooting“ of this operator manual.
10. Fill level of the **LEFT PRODUCT PACK**, here 100%.
11. Fill level of the **RIGHT PRODUCT PACK**, here 100%.

\* = this message can be turned off in some markets | \*\* = cold drinks are not available in all dispenser versions

## 4 - OPERATING

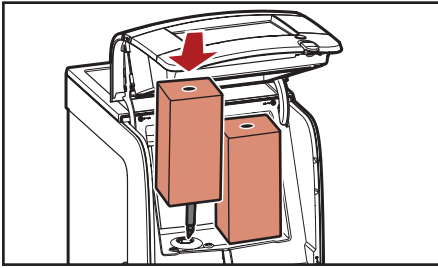

Fig. 4.1 - Place product pack

### Placing a product pack



**Caution:**

Never use a frozen or damaged product pack. Do not use a product pack, if the "Best before" date has expired.

1. Wash your hands before touching a product pack.
2. Read and follow the instructions on the rear of the pack.
3. Open the dispenser door.
4. Insert the product pack (fig. 4.1).
5. Close the dispenser door.
6. Dispense a test drink.

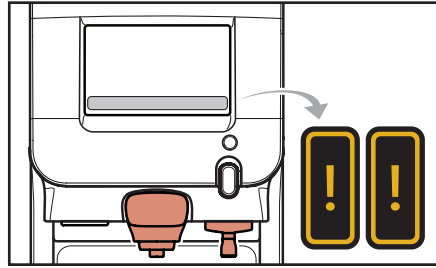

Fig. 4.2 - Empty product pack icon

### Empty product packs

If a product pack is empty, the corresponding drinks are shown as pale colored objects on the touch screen. The drinks cannot be delivered.

The icon for empty product pack will be shown in the system icons area (fig. 4.2) or on the status screen.

The delivery of drinks, which do only use the available ingredient, hot or cold water is still possible.

Call the operator of the dispenser to replace the empty product pack.

If an operator telephone number is set and enabled in the operator menu, the entered telephone number will be shown on the screen.

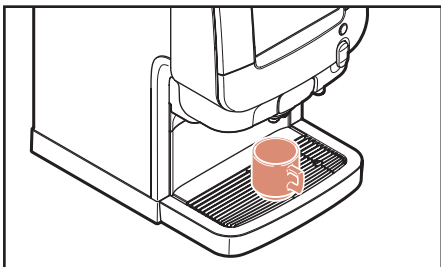

Fig. 4.3 - Cup placement

### Cup/pot placement

The dispenser provides two product outlets (fig. 4.4):

- Center: for milk, cocoa, tea or coffee drinks\*
- Right: for water

**Caution:**  
Place your cup or pot under the outlet of your choice - center for drinks, right for water.

Place your cup on the cup tray (fig. 4.3). A special dispenser foot is required when using large pots.

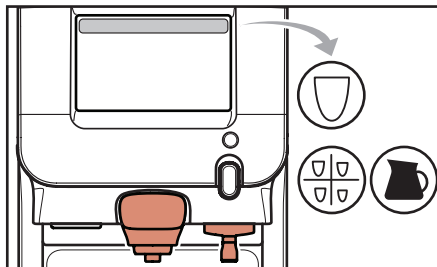

Fig. 4.4 - Touch screen and drink outlets

### Drink delivery

**Warning:**  
**The liquids dispensed by the dispenser are hot! Avoid scalding! Keep hands and other body parts away from the dispenser while drinks are being delivered. Never leave children unsupervised near the dispenser.**

Each of the menus and functions below can be turned on or off by the service technician. Contact your Cafitesse systems supplier if you want this altered.

The Excellence Touch dispenser provides several possibilities for drink delivery (fig. 4.4):

- Portioned delivery as “Make your own”, “Drinks”, or “Pots” on the touch screen.
- Free flow delivery of water with the hot water button, see fig. 4.10 on page 14.

#### Portioned delivery

The START delivery button only needs to be tapped once. The delivery stops automatically after one portion is delivered.

\* = drink selections depend on dispenser version and settings

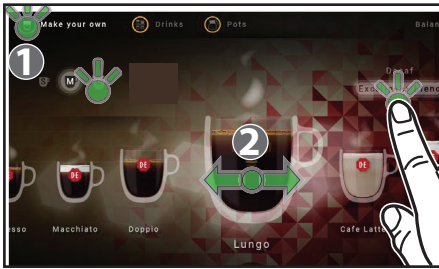

Fig. 4.5 - Choices of "Make your own"

### "Make your own" menu



**Note:**

If you activate drink settings, but do not START the drink delivery, the dispenser will return to the default state after a few seconds.

1. Tap on the upper left icon "Make your own" (1) on the touch screen, when the dispenser is in delivery mode (fig. 4.5).
2. Select from the touch screen
  - **THE REQUESTED DRINK (2)** - move the drink of your choice to the center of the screen (fig. 4.5)



**Note:**

Always use the cup size for drink delivery, which corresponds to your drink size selection.

- **DRINK SIZE** - tap on S(mall), M(edium), or L(arge) (fig. 4.5)
- **INGREDIENTS** - blend selection can be used in specific dispenser configurations with two coffee blends. (fig. 4.5)

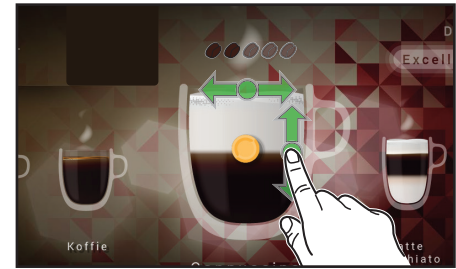

Fig. 4.6 - "Make your own" - strength > ratio

- **DRINK STRENGTH** - move the puk, which is located in the middle of the cup, to the left or to the right (coffee beans are highlighted, which indicate the strength of the drink) (fig. 4.6)
- **RATIO OF INGREDIENTS** (applicable for mixed drinks) - move the puk up or down to adjust the portions of ingredients (fig. 4.6).

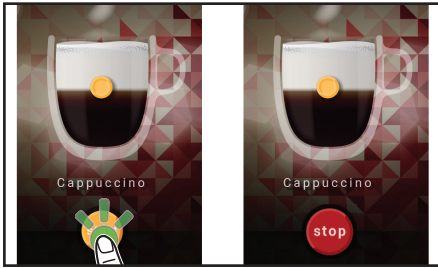

Fig. 4.7 - START and STOP drink delivery

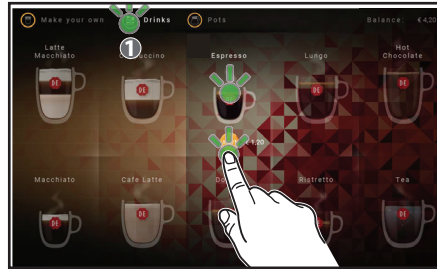

Fig. 4.8 - "Drinks"



**Warning:**

**The liquids dispensed by the dispenser are hot! Avoid scalding! Keep hands and other body parts away from the dispenser.**

3. Place a cup on the cup tray.
4. Tap on the START drink delivery button on the touch screen (fig. 4.7).

The drink is delivered into your cup.  
The touch screen shows a correspondent animation.

- Tap on the STOP drink delivery button on the touch screen, if you would like to interrupt the drink delivery (fig. 4.7)

**"Drinks" menu**

1. Tap on the upper middle icon "Drinks" (1) on the touch screen, when the dispenser is in delivery mode (fig. 4.8)
2. Tap on the drink of your choice.
3. Place a cup of the size, which fits to your drink selection.



**Warning:**

**The liquids dispensed by the dispenser are hot! Avoid scalding! Keep hands and other body parts away from the dispenser.**

4. Tap on the START delivery button.

The drink is immediately delivered.

\* = cold drinks are not available in all dispenser versions

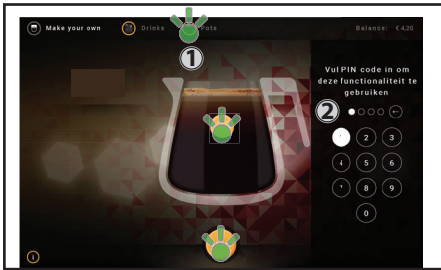

Fig. 4.9 - "Pots"

### "Pots" menu

1. Tap on the upper right icon "Pots" (**1**) on the touch screen, when the dispenser is in delivery mode (fig. 4.9).
2. Type in the PIN (**2**), if applicable (fig. 4.9).
3. Tap on the drink of your choice.
4. Drag the puck up or down for the requested pot size.
5. Place a pot of the requested size.



#### Warning:

**The liquids dispensed by the dispenser are hot! Avoid scalding! Keep hands and other body parts away from the dispenser.**

6. Tap on the START delivery button.

The drink is immediately delivered.

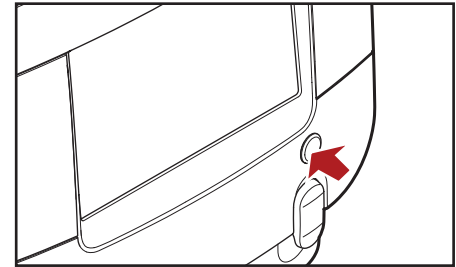

Fig. 4.10- Free flow delivery of hot water

### Hot water button (free flow delivery)

1. Place a cup or a pot of your choice under the right hot water outlet.



#### Warning:

**The liquids dispensed by the dispenser are hot! Avoid scalding! Keep hands and other body parts away from the dispenser.**

2. Press the hot water button and hold it pressed until the requested volume of hot water is delivered (fig. 4.10).



#### Note:

We recommend portioned delivery with fixed cup sizes in self-service areas.



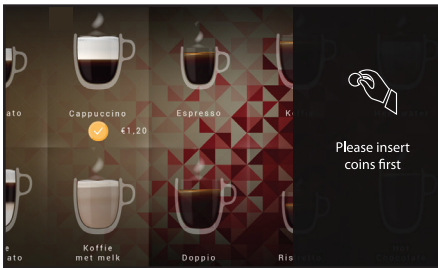

**Fig. 4.11- Drink delivery with payment system**

### **Drink delivery with payment system**

When a payment system is installed and set to “payed mode”:

1. Insert a sufficient amount of cash or e-cash into the payment system, please see fig. 4.11.
2. Select your drink and place a cup or pot under the related outlet.



#### **Warning:**

**The liquids dispensed by the dispenser are hot! Avoid scalding!  
Keep hands and other body parts away from the dispenser.**

3. Start the drink delivery.

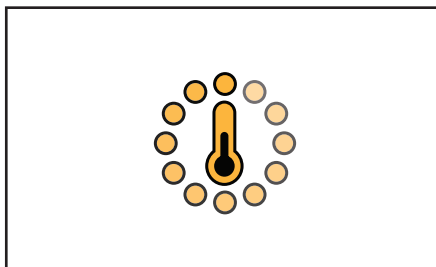

Fig. 4.12- Heating icon

### Switching off the dispenser

Please take the following preparations when the dispenser is not to be used for a long period, e.g. holidays:

1. Remove the product packs and check the expiry date.
2. Store the product packs in a refrigerator until you switch the dispenser back on again. When the expiry date has passed, throw the product packs away.



#### Caution:

Do not freeze product packs.

3. Do a complete cleaning procedure of the dispenser.
4. Pull the power plug out of the socket.
5. Close the water tap.

### Switching on the dispenser

1. Open the water tap.
2. Insert the power plug.

The dispenser starts heating up water and starts cooling down the cooling compartment. Drink delivery will be blocked until the water in the boiler has reached the correct temperature.

3. The heating icon (busy thermometer) will be shown on the touch screen (fig. 4.12).
4. Once the water has reached the preset temperature, the heating icon will disappear from the display, the dispenser is now ready for operation.



#### Note:

Heating the water inside the boiler will take approximately 15 minutes at room temperature. The cooling of the product compartment can take 24 hours or more.



#### Note:

If the dispenser has been shut down for longer periods, the date and time must be set so the programmed cleaning cycles and eco settings are reactivated.



Fig. 4.13- Language and Country

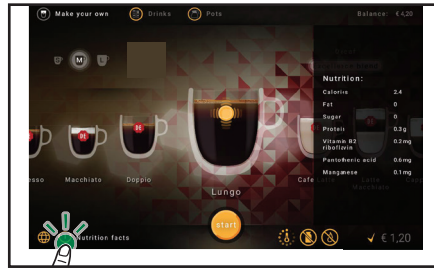

Fig. 4.14- Nutrition facts

## Various Settings and Information

### Language and country specific settings

1. Tap on the world icon in the lower left corner of the delivery mode touch screen (fig. 4.13).  
The list of countries and their items appears on the right side of the screen.
2. Scroll up and down until the requested country is shown.
3. Tap on the flag and country to select the language and specific settings, such as drink names, currency, and so on.

### Nutrition facts

- Tap on the nutrition facts icon in the lower left corner of the delivery mode touch screen (fig. 4.14).  
The list of nutrition facts of the selected drink is shown on the right side of the screen.

## 5 - CLEANING

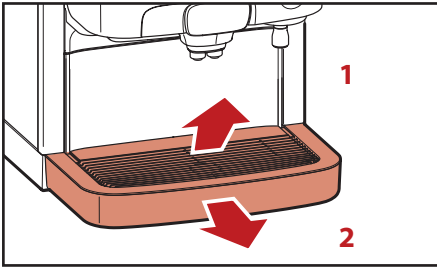

Fig. 5.1 - Remove cup & drip trays

### Exterior cleaning

**Note:**  
It is advised to clean the exterior of the dispenser daily.

1. Remove the cup tray (fig 5.1, 1).
2. Remove the drip tray (fig 5.1, 2).
3. Empty the drip tray.

**Note:**  
Check and empty the drip tray at regular intervals.

4. Clean the cup and drip trays.
5. Put the parts back in place.
6. Clean the exterior of the dispenser with a damp, clean cloth.

### Cleaning procedures

There are two different cleaning programs:

- "Flushing" the drink outlets
- "Complete Cleaning" the cooling compartment and the drink outlets.

You can select the weekdays for "Flushing" and "Complete Cleaning" programs in the operator menus 3 > 3.6 > 3.6.5 or 3.6.7.

**Caution:**  
It is mandatory to run the "Complete Cleaning" program at least once a week to guarantee food safety. In addition, Milk-Coffee and Choco-Coffee versions also need to run the "Flushing" program at least once a week.

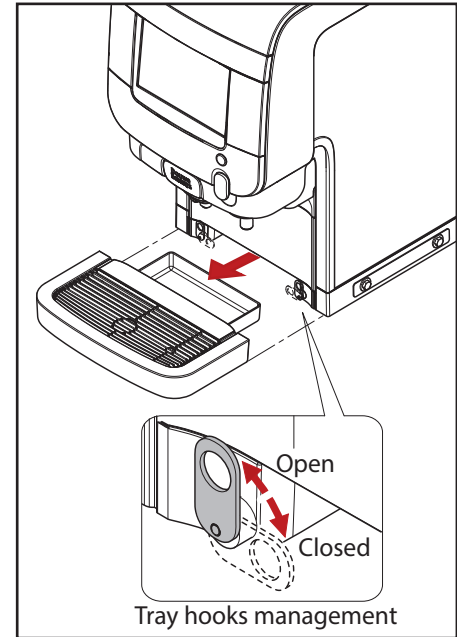

Remove drip tray Excellence Touch Marine

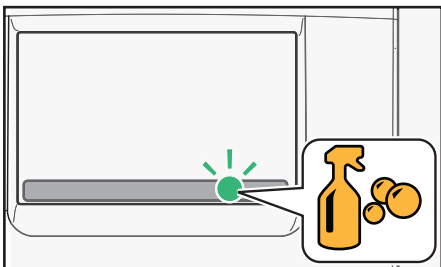

Fig. 5.2 - Cleaning icon

### When to clean the dispenser

Run the cleaning program when the cleaning icon appears in the display (fig. 5.2).

If the dispenser is not cleaned and/or flushed within 24 hours, the drink delivery will be blocked.

Start the cleaning program to resume delivery.

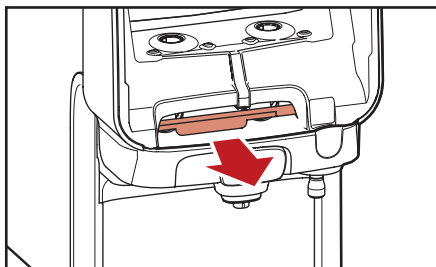

Fig. 5.3 - Pull red release bar

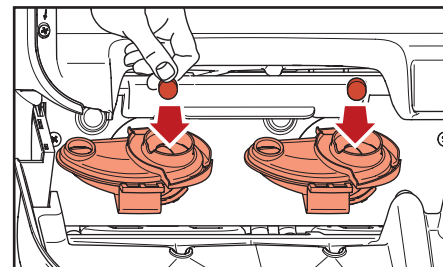

Fig. 5.4 - Insert Rinza cleaning tablets

### Flushing



#### Note:

Only Milk-Coffee and Choco-Coffee dispensers require Rinza cleaning tablets.

1. Enter the flushing program as follows:
  - Tap on the cleaning icon, which is shown on the touch screen, when flushing is due (fig. 5.2).
  - Start the operator mode by insertion of the operator USB key **OR** by input of the PIN code via the touch screen, if this function is enabled (see chapter “Programming”, menu 1.1).



#### Note:

Flush the dispenser at any time by starting the operator mode.

Follow the instruction on the screen:

2. Open the dispenser door.
3. Pull the red release bar to open the outlet compartment (fig. 5.3).
4. Insert a Rinza cleaning tablet in each of the mixing bowls (fig. 5.4).
5. Press the outlet compartment upwards until you hear a beep.
6. Close the dispenser door.

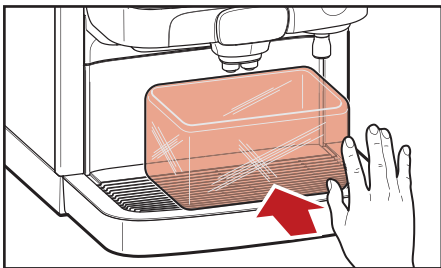

Fig. 5.5 - Place container

Follow the instruction on the screen:

7. Place a container under the drink and hot water outlets (fig. 5.5)
8. Tap on "OK" to confirm (fig. 5.6), that Rinza cleaning tablets are inserted and that the container is placed.

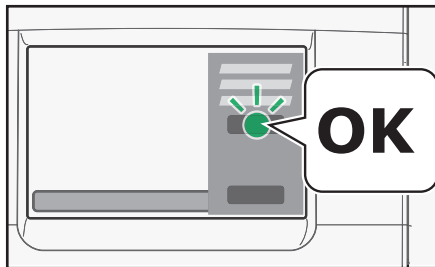

Fig. 5.6 - Tap on OK during flushing/complete cleaning

Follow the instruction on the screen:



**Warning:**

**The liquids dispensed by the dispenser are hot! Avoid scalding! Keep hands and other body parts away from the dispenser.**

9. Tap on "OK" to start flushing with hot water. (fig. 5.6).

The progress is shown in the screen.

When done, the dispenser is ready for use.

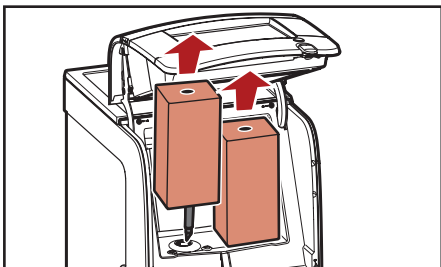

Fig. 5.8 - Remove packs

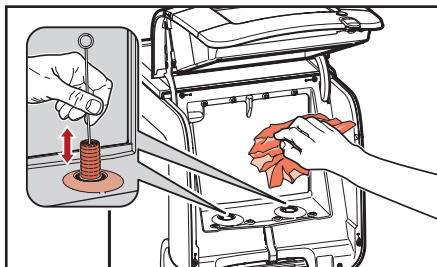

Fig. 5.9 - Clean cooling compartment

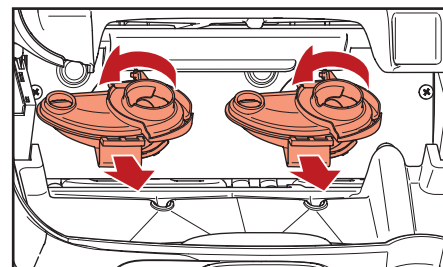

Fig. 5.10- Remove mixing bowls

## Complete cleaning

**Note:**  
Only Milk-Coffee and Choco-Coffee dispensers require Rinza cleaning tablets.

1. Enter the complete cleaning program as follows:
  - Tap on the cleaning icon, which is shown on the touch screen, when complete cleaning is due (fig. 5.2).
  - Start the operator mode by insertion of the operator USB key **OR** by input of a code via the touch screen, if this function is enabled (see chapter "Programming", menu 1.1).

**Note:**  
Do the complete cleaning of the dispenser at any time by starting the operator mode.

Follow the instruction on the screen:

2. Open the dispenser door.
  3. Remove the product packs (fig. 5.8).
- Note:**  
It is recommended to use the exchange kit, which consists of clean mixing bowls and sealing rings, to save time.
4. Clean the doser opening with a brush and the interior of the cooling compartment with a clean, damp cloth (fig. 5.9). Dry with a clean paper cloth.

5. Place the product packs back if they have not passed the expiry date. Else, place new product packs.

Follow the instruction on the screen:

6. Clean the mixing bowls:
  - a. Pull the red release bar to open the outlet compartment (fig. 5.3).
  - b. Rotate the mixing bowls counter-clockwise to release and pull to remove them (fig. 5.10).

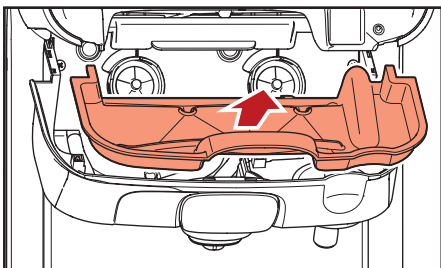

Fig. 5.11- Remove internal drip tray

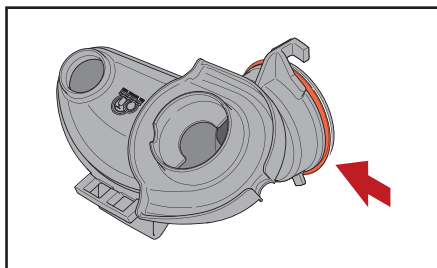

Fig. 5.12- Mixing bowl sealing ring

- c. Remove the internal drip tray and clean it, if necessary (fig. 5.11).
- d. Clean the mixing bowls:
  - Either in a dishwasher (max. temperature 90°C / 194°F), or
  - Soak them for 15 minutes in warm water with a food grade cleaning agent.
- e. Soak the sealing rings for 15 minutes in warm water with a food grade cleaning agent.



**Note:**

Comply with the safety instructions and cleaning instructions on the cleaning agent packaging.

- f. Rinse the mixing bowls and sealing rings under a running tap and dry with a clean paper cloth.



**Caution:**

Check if the blue sealing rings are firmly attached to the mixing bowls (fig 5.12).

- g. Insert clean mixing bowls with sealing rings, then rotate them clockwise until they cannot turn further.

- h. Place the internal drip tray back (if removed).
- i. Insert a Rinza cleaning tablet in both mixing bowls (fig. 5.4).
- j. Press the outlet compartment upwards until you hear a beep.
- k. Close the dispenser door.



Follow the instruction on the screen:

7. Place a container under the drink and hot water outlets (fig. 5.5)
8. Tap on "OK" to confirm (fig. 5.6), that Rinza cleaning tablets are inserted and that the container is placed.

Follow the instruction on the screen:



**Warning:**

**The liquids dispensed by the dispenser are hot! Avoid scalding!  
Keep hands and other body parts away from the dispenser.**

9. Tap on "OK" to start flushing with hot water.

The progress is shown in the display.  
When done, the dispenser is ready for use.

# 6 - PROGRAMMING

## Introduction

This chapter lists the menus and functions, which are available in the dispenser.

The service technician can enable or disable these menus and functions. Therefore it may happen, that the menus and functions are hidden in your dispenser version.

Please contact your Cafitesse system supplier, if you would like to have your programming settings altered.

The description of the main functions below do not necessarily represent their order in the menu.

The software version can be updated using the service USB key.

The layout and appearance of icons/ screens in this manual may vary from those displayed on the dispenser touch screen depending on the dispenser configuration.

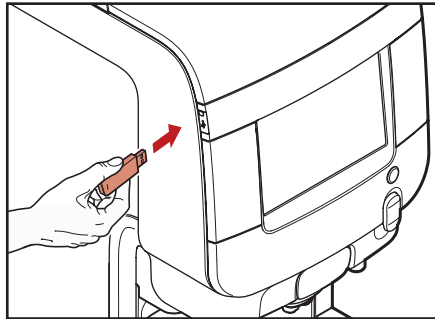

*Fig. 6.1 - Insert operator USB key*

## Access the Operator Menus

There are two ways to access the operator menus (operator mode):

- Insert the operator USB key (fig. 6.1)

or, if the service technician has enabled this function:

- Touch and hold the upper right corner of the touch screen and drag down.
- Enter the code "5555" to access the enabled operator menus.

The following menus can be available:

- Counters (statistics) - read out drink counters
- Change drink volume/strength
- Set date, time, and language
- Execute flushing or complete cleaning
- Cleanings days - set weekdays for flushing and complete cleaning
- Energy saving settings
- Enable/disable telephone number for the operator.
- Set countdown when pack is replaced to activate almost empty messages
- Error readout (and reset)
- Drinks settings
- Price settings - only with payment system installed - see chapter "7 Payment Systems"
- Display settings

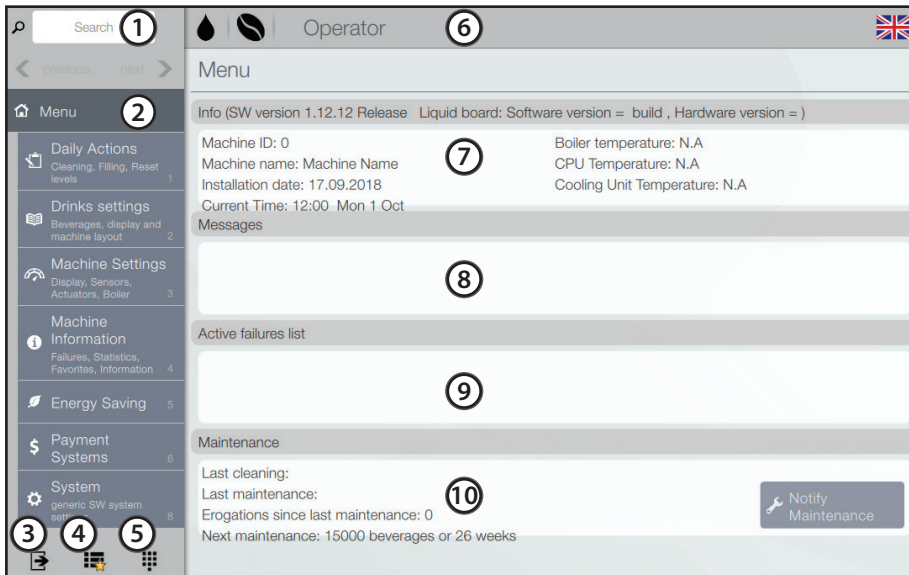

Fig. 6.2 - Programming home menu

Legend programming home menu (fig. 6.2):

- |                         |   |
|-------------------------|---|
| 1. Search field         | 6. Header operator mode                       |
| 2. Navigation side menu | 7. Information area                           |
| 3. "Exit" icon          | 8. Message area                               |
| 4. "Favourites" icon    | 9. Fault area                                 |
| 5. Keypad               | 10. Maintenance and cleaning information area |

## Programming Home Menu

The programming menu is displayed. By default, the touch screen shows both, the side navigation menu and function parameters.

- Scroll through the screens, if functions and/or parameters are not fully shown, e.g. in case of customization.

### Search Field (1)

Allows to search for a function by name.

1. Tap on the search field, the keyboard appears.
2. Type the name of the function. The functions that contain the typed text are displayed while typing.
3. Select the requested function from the list.

### Navigation Side Menu (2)

Shows the functions available for the current user profile and the "next / back" buttons

### **Exit Icon (3)**

Tap on the exit icon to leave the programming menu without saving. The dispenser steps back to the delivery mode.

### **Favourites Icon (4)**

The “favourites” are shortcuts to frequently used functions.

1. Tap on the “favourites icon”.  
A list of frequently used functions is shown on the screen.
2. Tap on a function in the list of “favourites” for quick access.

### **Add a function to the “favourites”:**

1. Activate the function you would like to add to the “favourites” list.
2. Tap on the ★-icon in the message bar.  
The ★-icon will change color and the function is added to the “favourites” list.

### **Remove a function from the “favourites”:**

1. Enter “favourites” and activate the function you would like to remove.
2. Tap on the ★-icon in the message bar.  
The ★-icon will change color and the function is removed from the “favourites” list.

### **Keypad (5)**

Use the keypad, e.g. to enter a code to access the programming menu according to the user profile.

### **Message Bar (6)**

Shows:

**Status icons**, e.g. water level, product pack empty.....  
Tap on the icons to get an indication on the status.

### **The menu access profile** (Technical, ...).

The menu functions are available depending on the profile used. The functions of a profile may not be available for another profile.

### **“Language” icon**

You can change the display language of the messages by tapping the flag icon.

### **“Add / delete favourites” icon**

### **Information Area (7)**

Displays information about the dispenser.

### **Message Area (8)**

Displays some information, such as statistics on the most popular selections, ...

### **Fault Area (9)**

Displays the active dispenser errors.

### **Maintenance Information Area (10)**

Displays the following occurrences:

- date of the previous cleaning
- date of the previous maintenance
- number of drink deliveries since the previous maintenance
- deadline for the next maintenance
- Tap on field “Maintenance notice”, to set the current date/time as date of the previous maintenance.

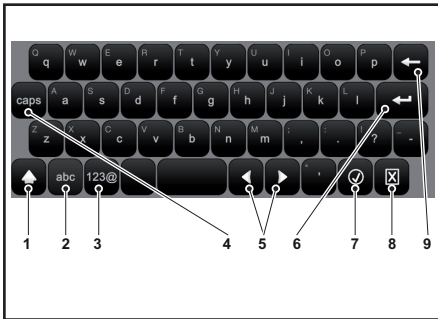

Fig. 6.3 - Keyboard

### Entering the Values

The values in the programming menu can be entered / modified using one of the following input options, which show up automatically:

#### Keyboard (fig. 6.3)

1. Enter the next uppercase character (shift)
2. Swap the keyboard from “numbers/symbols” to “letters”
3. Swap the keyboard from “letters” to “numbers/symbols”
4. Enter uppercase characters (caps lock)
5. Move the cursor in the text
6. Insert a new line (2-line text)

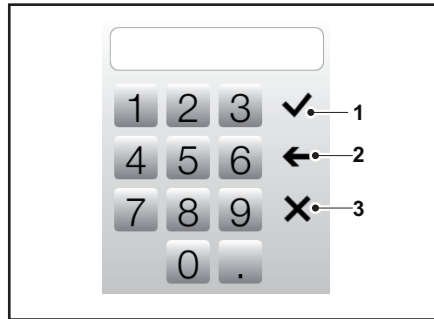

Fig. 6.4 - Keypad

7. Confirm the values
8. Cancel the entered values and closes the keyboard
9. Delete the last character entered (back space)

#### Keypad (fig. 6.4)

1. Confirm the values
2. Delete the last number entered (back space)
3. Cancel the entered values and closes the keypad

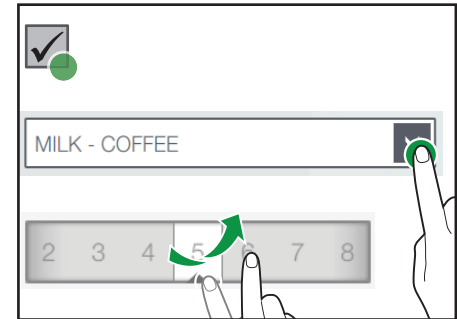

Fig. 6.5 - Checkbox, Drop Down List, Value Picker

#### Checkbox (fig. 6.5, detail 1)

- Tap on the checkbox to enable/disable the option.

#### Drop Down List (fig. 6.5, detail 2)

- Tap on the arrow symbol to open the drop-down list and select the value.

#### Value Picker (fig. 6.5, detail 3)

- Scroll to select the desired value.

## Daily Action (menu section 1)

### Cleaning

- Tap on menu items 1 > 1.1
- Follow the instructions in sections “Flushing” and “Complete Cleaning”, see chapter “Cleaning” (fig. 6.6).

### Filling

- Tap on menu items 1 > 1.2
- Enable the management of product pack levels.

### Cash Action

Please see chapter “7 Payment Systems”.

### Simplified Cleanshot

- Tap on menu items 1 > 1.5
- Enable or disable the cleanshot and set its parameters.

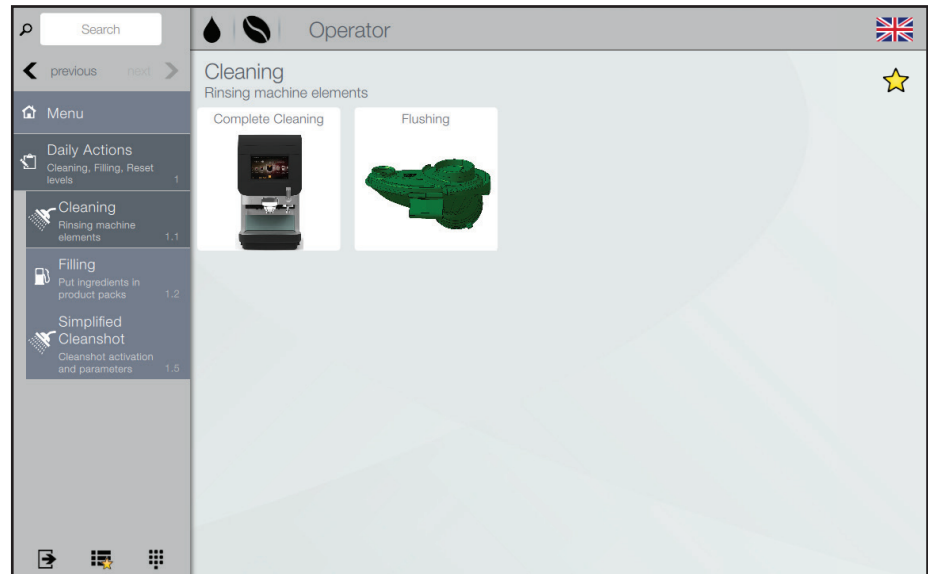

Fig. 6.6 - Cleaning

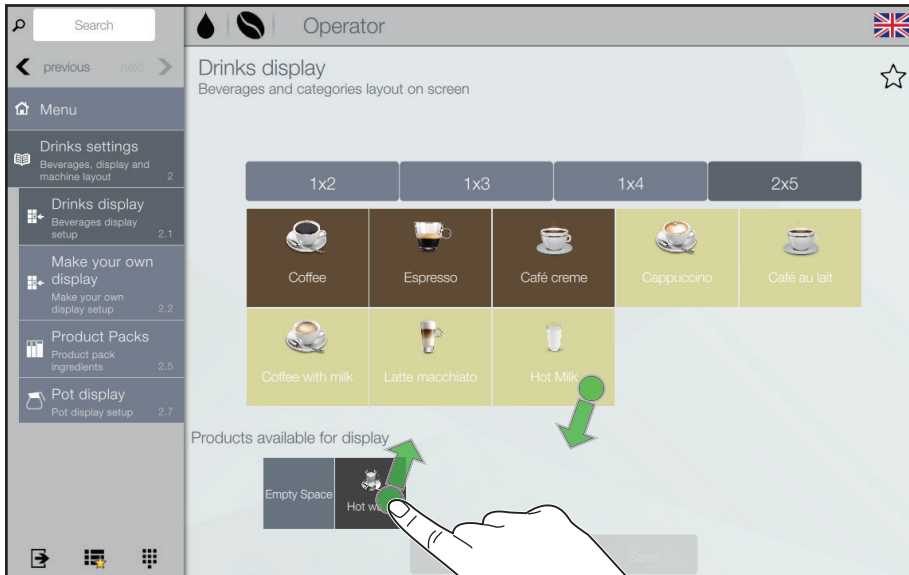

Fig. 6.7 - Drinks display

## Drinks Settings (menu section 2)

### Drinks display

- Tap on menu items 2 > 2.1

The drinks, which are enabled on your dispenser for delivery, are listed on the touch screen (fig. 6.7).

- Tap on fields "1x2", "1x3", "1x4", or "2x5" to set the drinks layout of the delivery mode.
- Move drinks from the lower part of the screen to the upper part to activate them for delivery.  
AND/OR  
Move drinks from the upper part of the screen to the lower part to deactivate them for delivery.
- Tap on "Save" to keep the modification OR  
Tap on "Discard" to leave the function without saving.

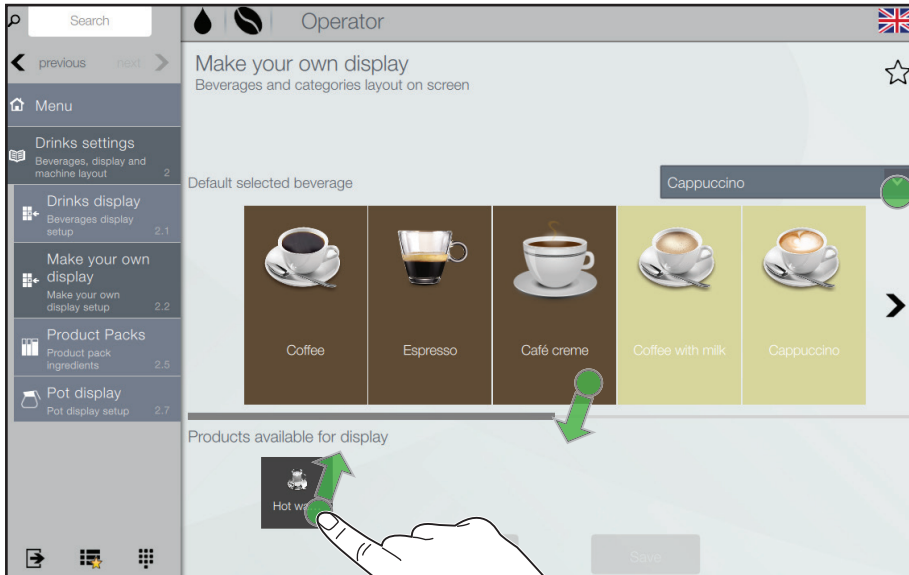

Fig. 6.8 - Make your own display

### Make your own display

You can modify the default drink selection for this menu.

- Tap on menu items 2 > 2.2

The drinks, which are enabled on your dispenser for delivery, are listed on the touch screen (fig. 6.8).

- Tap on the drop down list and select the drink, which should be displayed as default selection of the “Make Your Own” menu, if requested.
- Move drinks from the lower part of the screen to the upper part to activate them for delivery.  
AND/OR  
Move drinks from the upper part of the screen to the lower part to deactivate them for delivery.
- Tap on “Save” to keep the modification  
OR  
Tap on “Discard” to leave the function without saving.



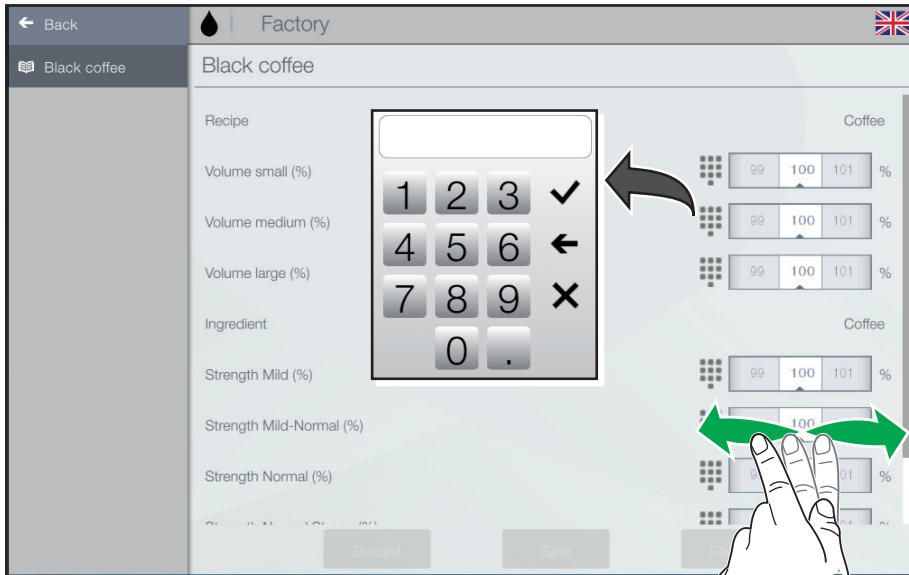



Fig. 6.9 - Recipe Editor (Volume / Strength)

## Recipe Editor (Volume / Strength)

- Tap on menu items 2 > 2.5 > 2.5.4

The drinks, which are enabled on your dispenser, are listed on the touch screen. Adjust the preset volume and strength of a drink:

- Tap on the  icon of the drink, you would like to modify.
- Set the requested values by keypad or value picker (fig. 6.9).

 **Note:** According to your request, you can adjust values between

- 80% and 120% for volume
  - 90% and 110% for strength
- Tap on "Save" to keep the modified values  
OR  
Tap on "Discard" to leave the function without saving.

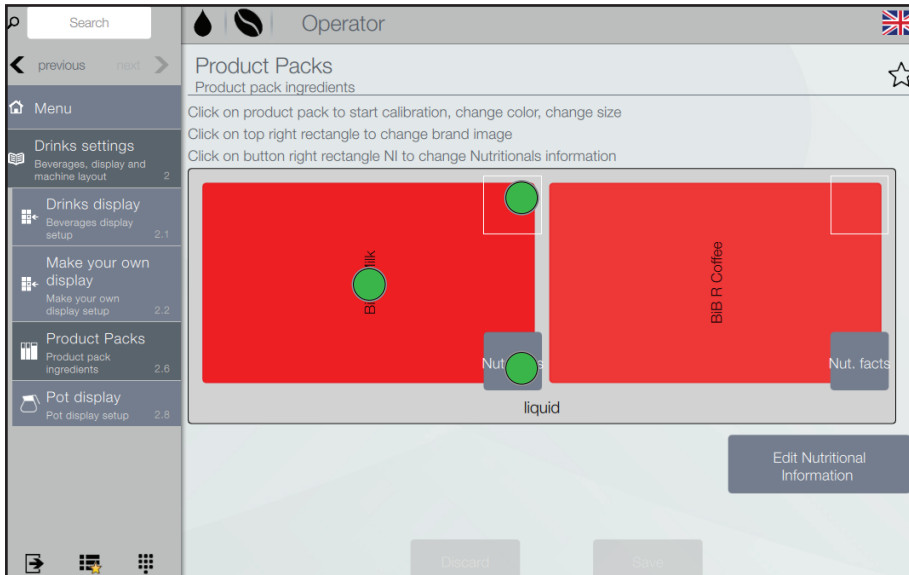

Fig. 6.10- Product packs

## Product Packs Settings

- Tap on menu items 2 > 2.6
- Tap on the requested product pack on the screen (fig. 6.10) to
  - start the calibration of the product pack
  - set/change the color of the product pack
  - OR**
  - set/change the size of the product pack
- Tap on the upper right corner of the product pack on the screen to set/change the brand image
- Tap on the lower right rectangle of the product pack on the screen to set/change the nutrition information.
- Tap on “Save” to keep the modified values  
OR  
Tap on “Discard” to leave the function without saving.

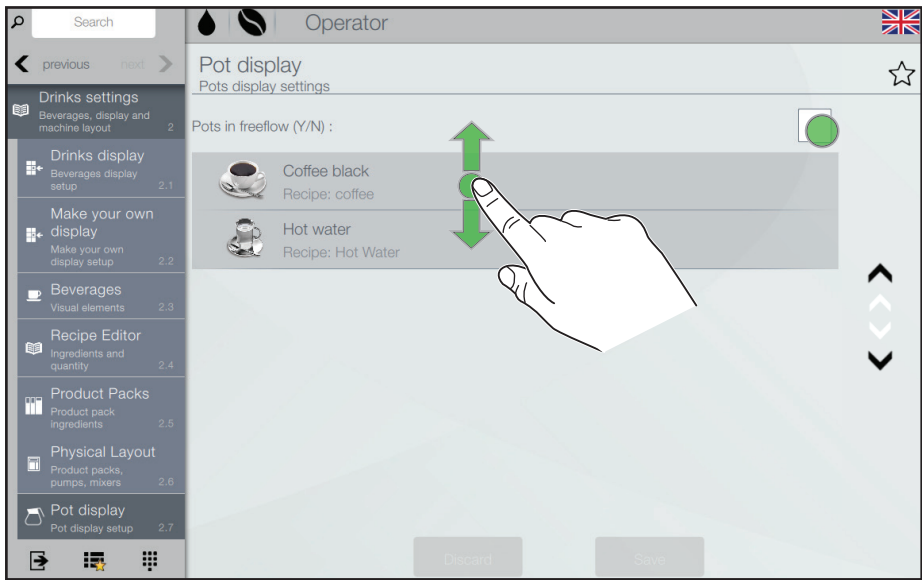

Fig. 6.11 - Pot display

### Pot display

- Tap on menu items 2 > 2.8

A checkbox for freeflow delivery and the drinks, which are enabled for pot delivery on your dispenser, are listed on the touch screen (fig. 6.11).

- Tap on the checkbox to define, if pots should be filled in freeflow mode (a check mark is shown) or not.

Adjust the list of pot drinks:

- Drag the drinks of the pot delivery list into the requested order.
- Tap on "Save" to keep the modified values OR Tap on "Discard" to leave the function without saving.

## ***Machine Settings (menu section 3)***

### **Display General Settings**

- Tap on menu items 3 > 3.3 > 3.3.3

Set the brightness of the touch screen with a maximum value of 100.

Enable / disable the display of:

- pages to be displayed at dispenser start up
- screen saver - set the delay time for the screen saver, after enabling it
- the PIN code to enter the pot page
- dispensing message
- cup logo
- nutritional information title
- temperature of the cooling compartment

### **Text / Feed**

- Tap on menu items 3 > 3.3 > 3.3.5

In normal operation and during the delivery of a drink, either RSS feed (news) or a fixed text can be displayed on the bottom line of the touch screen.

- To watch the RSS feed (news), connect the dispenser to the internet.
- Choose the internet address of the RSS feeds from the prepared list or enter a custom address.

By default, the dispenser is set to show fixed text messages (the dispenser is not connected to the internet):

- Type the text that you want to be displayed in normal operation.
- You can add more fixed text messages, touching "Add New".

### **Level of Product Packs**

- Tap on menu items 3 > 3.4 > 3.4.1

Enables / disables the level counters of the product packs.

Displays the two product packs with filling levels and adjustable parameters:

- Calculated amount: enables the counter that manages the "product running out" prealarms.

If the filling percentage of the product pack is shown in red, the product pack is in pre alarm status, see menu 1.2.

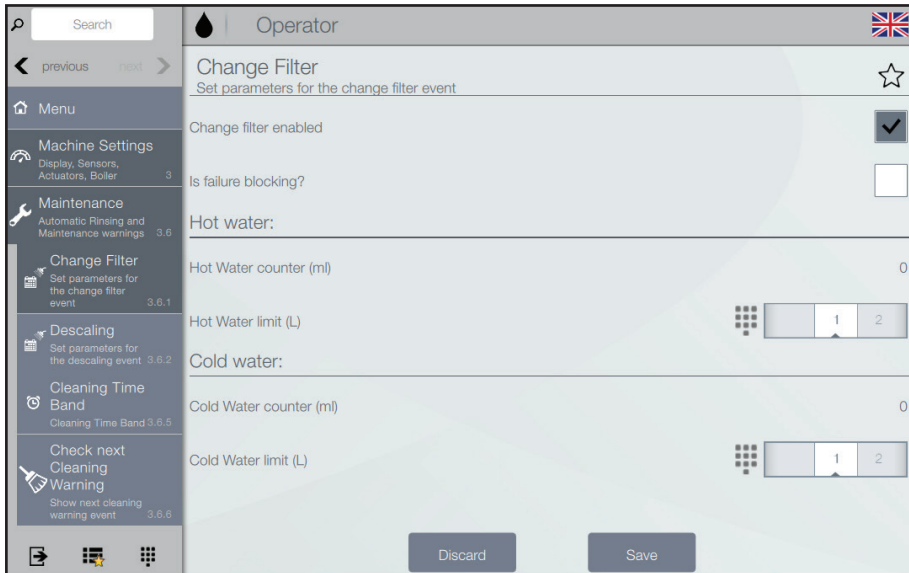

Fig. 6.12- Change Filter

## Change Filter

- Tap on menu items 3 > 3.6 > 3.6.1

Do the following settings (fig. 6.12):

- Enable the Change Filter function, if you use a water filter.
- Set, if the failure (counter value > water limit) should block the drink delivery or not.
- Set the water limit (hot and cold water) for filter changing.
- Tap on “Save” to keep the modified values  
**OR**  
Tap on “Discard” to leave the function without saving.

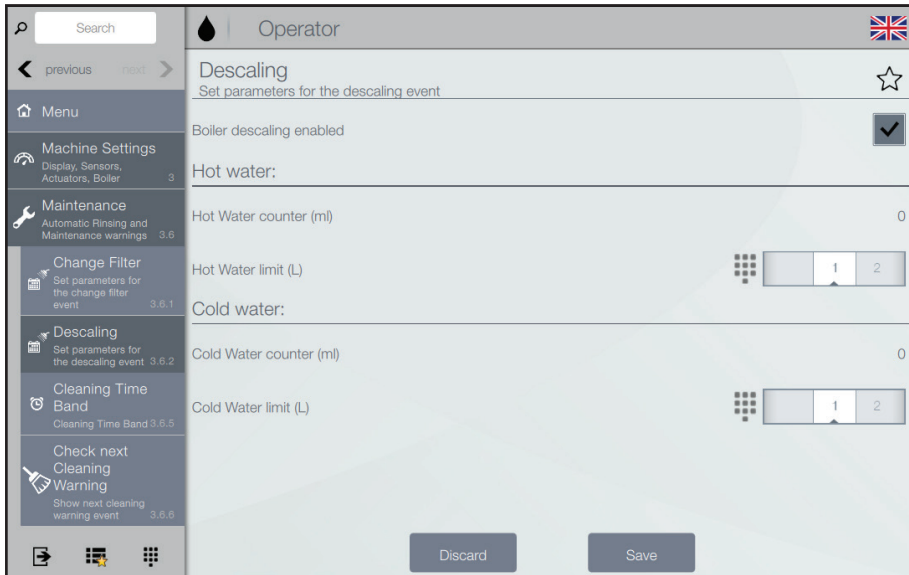

Fig. 6.13- Descaling

## Descaling

- Tap on menu items 3 > 3.6 > 3.6.2
- Enable the Descaling function, if you prefer a descaling of the boiler and other equipment in regular intervals (fig. 6.13).
- Set the water limit of hot and cold water for descaling.
- Tap on “Save” to keep the modified values **OR** Tap on “Discard” to leave the function without saving.

## Cleaning days

- Tap on menu items 3 > 3.6 > 3.6.5

Adjust the automatic cleaning settings of the dispenser:

- when / if the Complete Cleaning / Flushing programs should be performed
- the weekday to perform the Complete Cleaning / Flushing programs

You can add and remove Complete Cleaning / Flushing automatic cycles.

The automatic washes/rinses use hot water: danger of burns.



### Caution:

It is mandatory to run the **“Complete Cleaning”** program at least once a week to guarantee food safety. In addition, Milk-Coffee and Choco-Coffee versions also need to run the **“Flushing”** program at least once a week.

## Determine cleaning days

If you have a Coffee-Coffee version, the dispenser only needs to run the **“Complete Cleaning”** program once a week. You can select any day you prefer.

If you have a Milk-Coffee or a Choco-Coffee version, the dispenser needs to run both the **“Complete Cleaning”** and the **“Flushing”** programs at least once a week.

You must select at least two days with a maximum interval of 4 days.

The table below indicates which days can be combined (red = Complete Cleaning, gray = Flushing).

Sun	Mon	Tue	Wed	Thu	Fri	Sat
Sun	Mon	Tue	Wed	Thu	Fri	Sat
Sun	Mon	Tue	Wed	Thu	Fri	Sat
Sun	Mon	Tue	Wed	Thu	Fri	Sat
Sun	Mon	Tue	Wed	Thu	Fri	Sat
Sun	Mon	Tue	Wed	Thu	Fri	Sat
Sun	Mon	Tue	Wed	Thu	Fri	Sat



### Note:

You can always set more days for **“Complete Cleaning”** and/or **“Flushing”** than the minimum required number of days.

## ***Drink counters / Statistics*** ***(menu section 4)***

### **Show Statistics**

- Tap on menu items 4 > 4.2 > 4.2.1

Displays drink counters showing:

- the number of dispensed drinks
- date and time of last dispensing

### **Reset Statistics**

- Tap on menu items 4 > 4.2 > 4.2.2

Reset a counter:

- Tap on the “Reset now” button to set the counter value of the related drink to zero.

### **Show Audit**

See chapter “7 Payment Systems” for descriptions about the Show Audit function.



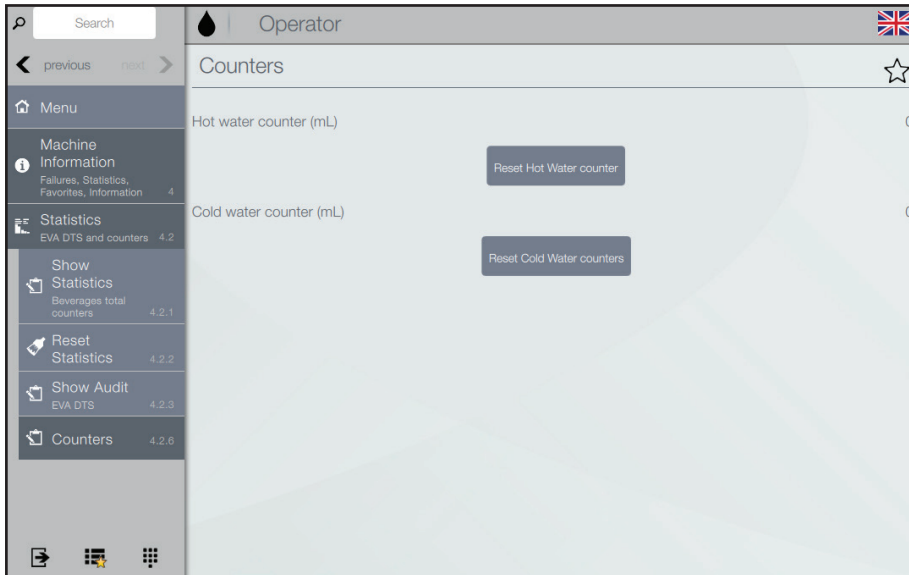

Fig. 6.14- Total Water Counter

## Total Water Counter

- Tap on menu items 4 > 4.2 > 4.2.6
- Tap on “previous” to leave the menu without change
- Tap on “Reset Hot Water counter” to set the hot water counter to zero (fig. 6.14)
- Tap on “Reset Cold Water counter” to set the cold water counter to zero

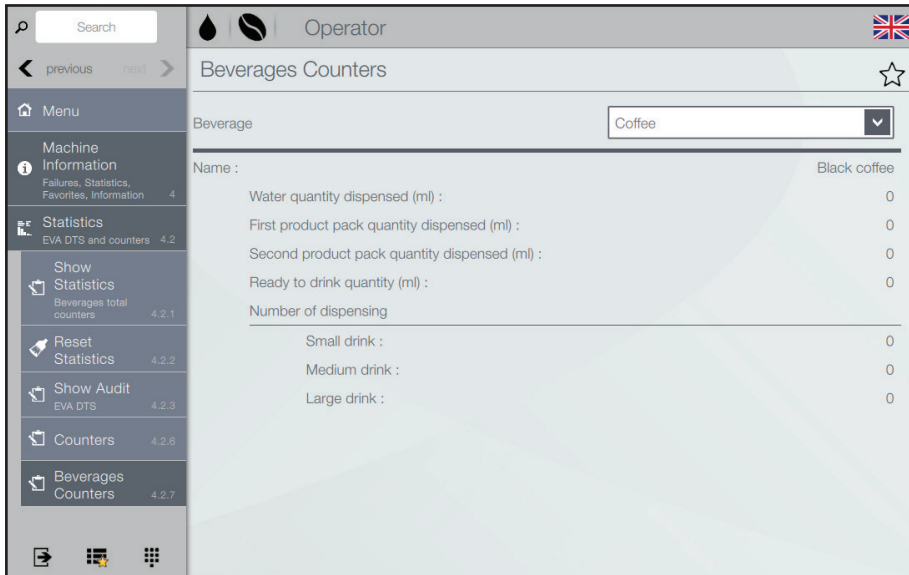

Fig. 6.15- Drink Counters

## Drink Counters

- Tap on menu items 4 > 4.2 > 4.2.7
- Tap on the pull down menu “Beverage” to select the requested drink (fig. 6.15).

The water, ingredient, and ready to drink quantities of the selected drink are shown.

The number of small, medium, and large drink dispensings are listed.

## Operator Information

- Tap on menu items 4 > 4.6

This function allows to enter the contact information (name and phone number) of the operator.

It will be displayed in case of certain errors.

You can decide whether the information should be displayed for errors that block the equipment and/or errors that do not block the equipment.

## ***Energy Saving (menu section 5)***

The energy saving function allows to enable, change the parameters, and set the time frames of the dispensers' energy saving.

### **Settings**

- Tap on menu items 5 > 5.1

Enables / disables power saving features. The dispenser allows to manage a few energy saving profiles.

Some parameters of each energy saving profile can be customized.

- “Soft Mode” Profile

This profile enables energy saving after a period of inactivity of the dispenser. When a selection is made, energy saving is disabled.

You can:

- set the number of minutes of inactivity of the dispenser after which to activate the profile

- set the lowered temperature of the boiler in the energy saving phase
- set the brightness of the touch screen normal, low, or off.

- “Deep Mode” Profile

This profile is active during the set time frames.

In the set time frames, the boiler temperature is lowered to the adjusted energy saving temperature.

You can:

- set the lowered temperature of the boiler in the energy saving phase
- set how many minutes in advance to start the heating of the boiler before the end of the time frame (e.g. 5 minutes before the end of the time frame, the boiler heating cycle is activated to reach the operating temperature).
- set the brightness of the touch screen normal, low, or off.

## Energy Saving Timebands

- Tap on menu items 5 > 5.2

### **Set the time frames of an energy saving profile (fig. 6.16):**

- Tap on the requested weekday to set the time frame.
- Tap on "Add event".
- Tap on the profile line (normal/soft/deep) to place a time frame.
- If necessary, drag the time frame to set the exact time in intervals of 15 minutes.
- Add as many time frames as requested.

### **Delete a time frame:**

- Tap on "Remove event".
- Tap on the time frame to be deleted.

### **Copy a time frame:**

You can copy the settings for each day of the week or for a single day:

- Tap on "Copy day profile", then
  - Tap on "Paste day profile to all days".  
OR
  - Tap on the requested weekday.
  - Tap on "Paste day profile".

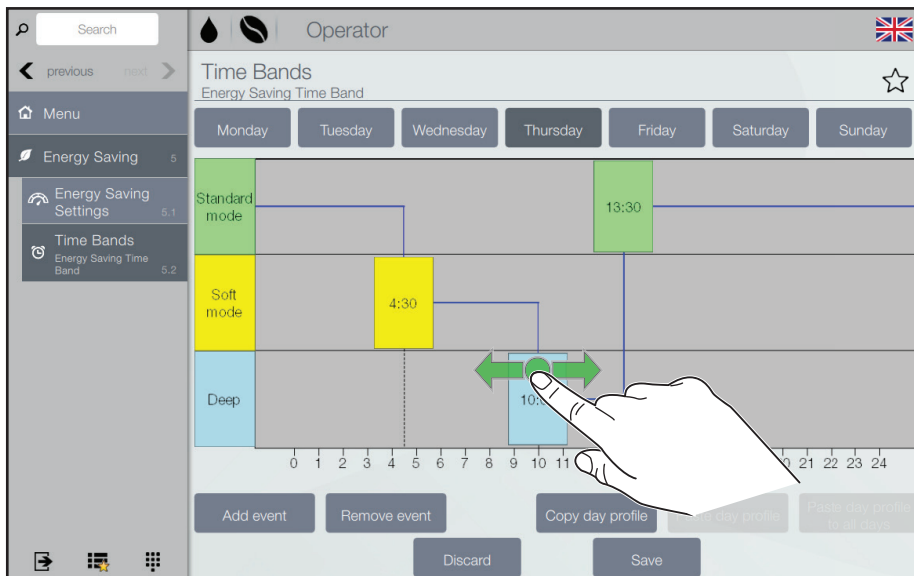

Fig. 6.16- Energy Saving Timebands

### **Save the energy saving profiles:**

- Tap on "Save".

### ***Payment Systems (menu section 6)***

For any functions and adjustment descriptions about payment systems, see chapter "7 Payment Systems".

### ***System (menu section 8)***

#### **Date / Time Settings**

- Tap on menu items 8 > 8.3

Adjust Date & Time settings:

- Tap on the  icon of Date and/or Time values
- Set the correct values by keypad or value picker, see page 24.
- Tap on "Save" to keep the modified values  
OR  
Tap on "Discard" to leave the function without saving.

#### **Languages**

- Tap on menu items 8 > 8.4

Adjust Language:

- Drag the items of the requested countries to the related positions inside the menu.
- Tap on "Save" to keep the modified values  
OR  
Tap on "Discard" to leave the function without saving.

#### **Information**

- Tap on menu items 8 > 8.9

Allows to view all the information about the dispenser software (version, theme used, configuration, ...)

# 7 - PAYMENT SYSTEMS

## **Introduction**

This chapter describes the operation and range of functions of the payment units used in connection with an Excellence-Touch dispenser.

As an operator, who is allowed to change settings and handle the coins, please read this chapter carefully, to ensure you have understood the payment operation.

The payment unit is designed for dispensers of the Excellence-Touch series. It is available in the following system versions:

- Coin Changer
- Card Reader

The payment unit is made up of a separate housing which is attached to the right side of the dispenser.

The payment unit is made for vending drinks from the dispenser.

Furthermore, you can manage the function of the payment unit by setting time bands for different prices and free vend.

## **Various payment functions**

### **Cash Action (menu 1.3)**



**Note:**

Enabled only for models with payment system coin changer.

- Tap on menu items 1 > 1.3

With the included functions you can:

- empty coin tubes
- load coins for coin box function
- check the total amount of money in coin mechanism

### **Show Audit (menu 4.2.3)**

- Tap on menu items 4 > 4.2 > 4.2.3

Displays the total number of payments and the total deliveries since last drink counters (statistics) reset, for each selection.

The audit data can be displayed by:

- Payed dispensing
- Free Vend dispensing
- Test Vend dispensing
- Cash Audit
- Ingredients

## Prices (menu section 6)

### Currency Symbol

- Tap on menu items 6 > 6.2 > 6.2.1
- Set up the currency symbol for the credit display.

### Global Drink Prices

The factory settings define the same price for all drinks (global price):

- Tap on menu items 6 > 6.2 > 6.2.2
- Modify all drink prices at once.

### Drink Price

For each drink it is possible to set a different price from the global price:

- Tap on menu items 6 > 6.2 > 6.2.3
- Select the requested drink and change the price.

### Free Vend Code

- Tap on menu items 6 > 6.2 > 6.2.4
- Enable/disable/modify the Free Vend Code (fig. 7.1)

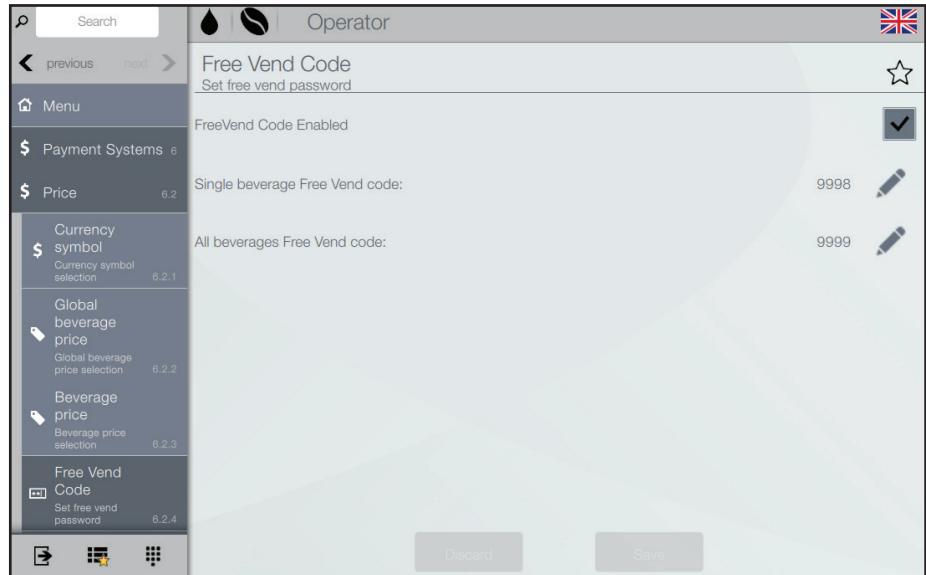

Fig. 7.1 - Free vend code

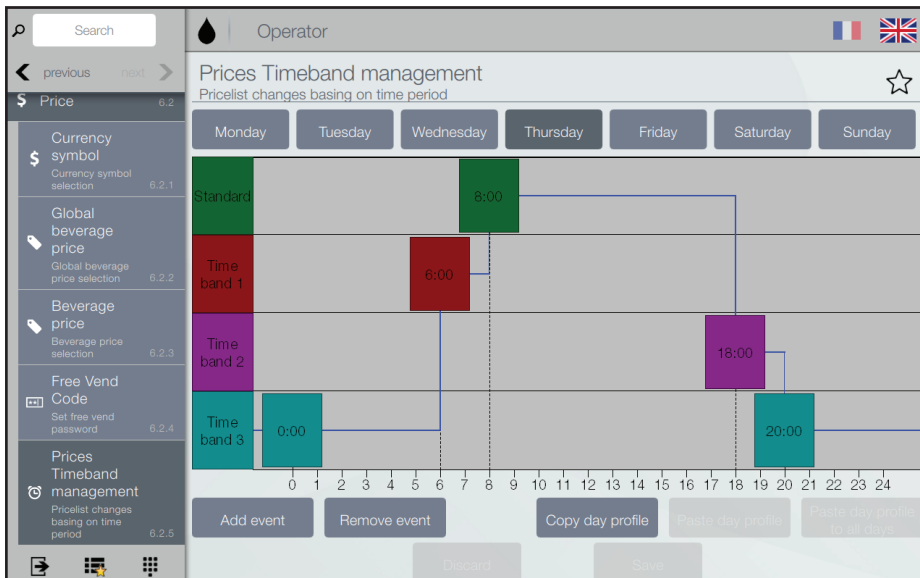

Fig. 7.2 - Prices Timebands management

### Prices Timebands management

- Tap on menu items 6 > 6.2 > 6.2.5

Set the time frames of a price profile (fig. 7.2):

- Tap on the requested weekday to set the time frame.
- Tap on "Add event".
- Tap on the profile line (Standard, Timeband 1, 2, or 3) to place a time frame.
- If necessary, drag the time frame to set the exact time in intervals of 15 minutes.
- Add as many time frames as requested.

Delete a time frame:

- Tap on "Remove event".
- Tap on the time frame to be deleted.

Copy a time frame:

You can copy the settings for each day of the week or for a single day:

- Tap on "Copy day profile", then
  - Tap on "Paste day profile to all days".
  - OR
  - Tap on the requested weekday.
  - Tap on "Paste day profile".

Save the energy saving profiles:

- Tap on "Save".



## ***Payment system protocols (menu section 7)***

You can set the following protocols for the available payment systems, and manage the relative functions.

Some parameters shared by several payment systems keep the set point even if you change the type of system.

### **Validator:**

#### **Immediate change (default: disabled)**

The amount relative to a selection is generally cashed after the machine has sent the "Successful selection" signal.

When you enable this function, the cash signal is sent at the start of the dispensing cycle.

The setup of this parameter is compulsory.

#### **Decimal point position**

To set up the decimal point position, i.e.:

0 - decimal point disabled

1 - XXX.X (one decimal place)

2 - XX.XX (two decimal places)

3 - X.XXX (three decimal places)

#### **Booking time (default: 7 seconds)**

To set up for the cash payment how long the dispenser displays the residual credit necessary to dispense the selection.

### **Line/value association**

When the display is positioned on the "LINE-VALUE ASSOC." function (line programming) of the "programming" menu, you can vary the value of the 6 coin lines of the validator from A to F.

### **Credit programming (overpay)**

You can decide whether:

- to cash the credit exceeding the selection amount after a welldefined time interval in seconds (parameter "deleted 000")
- to leave the credit exceeding the selection amount at disposal for a subsequent selection (parameter "maintained")

### **Executive:**

#### **Coinmechanism version**

You have to choose among the following payment systems for the Executive system:

- Standard
- Price holding
- UKEY (Price holding price display)

#### **Immediate change (default: disabled)**

The amount relative to a selection is generally cashed after the dispenser has sent the "Successful selection" signal.

When you enable this function, the cash signal is sent at the start of the dispensing cycle.

The setup of this parameter is compulsory.

#### **Booking time (default: 7 seconds)**

To set up for the cash payment how long the dispenser displays the residual credit necessary to dispense the selection.

**BDV:****Immediate change (default: disabled)**

The amount relative to a selection is generally cashed after the dispenser has sent the “Successful selection” signal. When you enable this function, the cash signal is sent at the start of the dispensing cycle. The setup of this parameter is compulsory.

**Booking time (default: 7 seconds)**

To set up for the cash payment how long the dispenser displays the residual credit necessary to dispense the selection.

**Type of dispensing**

To set the operation mode by multiple or single dispensing. In case of multiple dispensing, the change is not automatically given at the end of a successful delivery, but the credit will remain available for further dispensing. If you press the coin return button, the remaining credit will be returned if its value is lower than the maximum change value.

**Credit return (escrow lever)**

To enable/disable the credit return (by pressing the change return key) if no dispensing has been performed. If enabled, this function will provide for the return of the coins even if the first dispensing cycle has not occurred. If a delivery has failed for any reason, the change will be returned.

**Maximum credit**

Use this function to define the maximum accepted credit for inserted coins.

**Maximum change**

You can set a limit on the total amount of the change the coin mechanism will pay as soon as you press the change button or after one single dispensing. The credit exceeding the amount you have programmed by this function will be cashed.

**Accepted coins**

To define which coins shall be accepted among those recognised by the validator. For the coin/value correspondence check the label showing the position of the coins on the coin mechanism.

**Coins accepted for change**

To program the refusal of a coin in case of “exact amount”. For the coin/value correspondence check the label showing the position of the coins on the coin mechanism.

### **Exact change equation**

To define the combination of empty tubes intended to set the coin mechanism to the “exact amount” mode. All possible combinations of empty tubes are listed here below.

For reasons of simplicity, the combination is described with reference to tubes A, B and C, where tube A will receive the lowest-value coins and tube C the highest-value coins.

0 = A or (B and C)

1 = A and B and C

2 = A and B only

3 = A and (B or C)

4 = A only

5 = A or B only (default)

6 = A or B or C

7 = A or B only

8 = A or C only

9 = B and C only

10 = B only

11 = B or C only

12 = C only

### **Distribution buttons**

Use this function to enable or disable the buttons arranged on the coin mechanism in order to discharge the coins in the change tubes.

### **C.P.C. unit**

It is intended to inform the coin mechanism whether some peripheral units have been installed or removed from the serial connection (peripheral units of the C.P.C type - the default control unit is always enabled).

### **Exact change (minimum tube level)**

To warn the user in advance to “Insert exact amount” by adding a number of coins between 0 and 15 to the number of coins that has been programmed to establish the state of full change tubes.

### **VMC free sale**

Most of the payment systems complete with a BDV protocol is intended to manage the free sale function.

However, there are some payment systems not having this function.

In this case, it is necessary to enable the VMC (vending machine control, disabled by default) free sale and to set the price of selections to zero if some selections are dispensed on a free basis.

## **MDB:**

### **Immediate change (default: disabled)**

The amount relative to a selection is generally cashed after the dispenser has sent the “Successful selection” signal. When you enable this function, the cash signal is sent at the start of the dispensing cycle. The setup of this parameter is compulsory.

### **Decimal point position**

To set up the decimal point position, i.e.:

- 0 - decimal point disabled
- 1 - XXX.X (one decimal place)
- 2 - XX.XX (two decimal places)
- 3 - X.XXX (three decimal places)

### **Booking time (default: 7 seconds)**

To set up how long the dispenser displays the residual credit necessary to dispense the selection.

## **Type of dispensing**

To set the operation mode by multiple or single dispensing. In case of multiple dispensing, the change is not automatically given at the end of a successful delivery, but the credit will remain available for further dispensing. If you press the coin return button (if the function is enabled), the remaining credit will be returned up to the maximum change value.

### **Obligation to buy**

To enable/disable the operation of the coin return button before dispensing a product.

- ON: the change is returned after having selected a product
- OFF: the change is returned just after having pressed the coin return key (the dispenser is acting as a coin changer)

### **Maximum credit**

Use this function to define the maximum accepted credit for inserted coins.

## **Maximum change**

You can set a limit on the total amount of the change the coin mechanism will pay as soon as you press the change button or after one single dispensing.

The credit exceeding the amount you have programmed by this function will be cashed.

### **Accepted coins**

To define which coins shall be accepted among those recognised by the validator when the change tubes are full. For the coin/value correspondence check the coin mechanism configuration.

### **Returned coins**

To define which coins shall be used to give the change among those available in the tubes. This parameter is active only with the coin mechanisms not intended to manage the choice of the tube in use automatically (Auto changer payout). For the coin/value correspondence check the coin mechanism configuration.

### **Accepted bills**

To define which bills shall be accepted among those recognised by the reader. For the bill/value correspondence check the reader configuration.

### **Coins accepted for exact change**

To define which coins shall be accepted among those recognised by the validator when the machine is in the “exact amount” mode.

For the coin/value correspondence check the coin mechanism configuration.

### **Bills accepted for exact change**

To define which bills shall be accepted among those recognised by the reader when the machine is in the “exact amount” mode.

For the bill/value correspondence check the reader configuration.

### **Cashless private**

To protect the users’ privacy, this function is intended to display the string “-----” in the place of the credit on the cashless system.

### **Residual credit**

You can decide whether to cash any credit exceeding the selection amount after a well-defined time interval (deleted later) or to leave it at the user’s disposal (maintained).

### **Cash-sale command**

The function is used to give evidence that cash transactions have occurred by means of a cashless system.

The values available are listed here below:

- 0 standard operation: cash transactions are recorded as such
- 1 forced sending to cashless 1: cash transactions are recorded as transactions performed by the first cashless system
- 2 forced sending to cashless 2: cash transactions are recorded as transactions performed by the second cashless system

### **Parallel device**

Use this function to enable the presence of a validator or parallel bill reader to recharge the keys.

### **Exact change equation**

To choose among 15 different control algorithms to enable the dispenser to give the change at the end of the selection. Every single algorithm checks a series of requirements (the amount of coins in the tubes or the empty or full state) of the tubes the coin mechanism will use to give the change.

The “No change” condition occurs when the tubes assigned to the chosen algorithm have achieved the minimum level of coins (“minimum tube level” parameter). For reasons of simplicity, the combination is described with reference to tubes A, B, C and D, where tube A will receive the lowest-value coins and tube D the highest-value coins.

0 = A or B or C or D

1 = A or B

2 = C or D

3 = A or D

4 = A only

5 = B only

6 = C only

7 = A and D

8 = C and D

9 = A and B  
10 = A and B and C and D  
11 = A and C or A and D  
12 = A only or C and D  
13 = D only  
14 = A and B and C

For example: the "10" equation will display the "No change" message when all four tubes have achieved the minimum level. The "04" equation will display the "No change" message only when tube A (lower-value coin) has achieved the minimum level of coins.

### **Maximum cashless key credit**

Use this function to set up the maximum credit a cashless key/card may have to be accepted by the system. If the key has got a higher value, it will be rejected. The setup value shall always be higher than or equal to the value set for the "Maximum cash revalue" function.

The setup value shall always be higher than or equal to the value set for the "Maximum cash revalue" function; if modified and lower, it will be automatically set to the same value as the "Maximum cash revalue".

### **Maximum cashless key recharged**

The function is used to set up the maximum credit you can charge on a key or card system.

### **Minimum tube level**

To set a number of coins between 0 and 15 in order to establish the state of full change tubes and to warn the user to "insert the exact amount".

### **Bill reader function (bill revalue)**

To enable the bill reader only to recharge the credit on the cashless system (key or card).

### **Undefined credit cash**





This function is intended to accept cashless payment systems (key or card) or not if the cashless system credit is not defined.

### **User groups**

The function is used to associate a price list (list 1, list 2 and list 3) to the groups of users (from 1 to 5).

All groups of users are associated to the list by default.

# 8 - TROUBLESHOOTING

Display message	Cause	Action
	The product pack is: <ol style="list-style-type: none"> <li>1. empty</li> <li>2. incorrectly positioned</li> <li>3. or not present</li> </ol>	<ol style="list-style-type: none"> <li>1. Replace the empty product pack, <i>see page 11</i>.</li> <li>2. Check whether the product pack is inserted correctly, <i>see page 11</i>.</li> <li>3. Insert a product pack. Call the operator when the number is shown on the display.</li> </ol>
	The water in the boiler has not yet reached the required temperature.	<ul style="list-style-type: none"> <li>• The drink delivery of the dispenser is blocked until the temperature reaches the correct value.</li> </ul>
	The dispenser must be cleaned.	<ul style="list-style-type: none"> <li>• Start the cleaning program on the same day, <i>see page 16</i>. Call the operator when the number is shown on the display.</li> </ul>
 <p>drinks are greyed out</p>	The drink delivery is blocked because the dispenser was not cleaned as scheduled.	<ul style="list-style-type: none"> <li>• Start the cleaning program immediately, <i>see page 16</i>. Call the operator when the number is shown on the display.</li> </ul>
	The water filter of the dispenser must be replaced.	<ul style="list-style-type: none"> <li>• Contact service to replace the water filter.</li> </ul>

Display message	Cause	Action
Err 10	Boiler safety tripped error	<ul style="list-style-type: none"> <li>Water overboiled or water overflow from boiler, check thermal protector. Reset possible by the operator in case the optional kit Marine Easy overflow reset has been installed.</li> <li>Contact service if the error remains.</li> </ul>
Err 17/18/19	Water system error	<ul style="list-style-type: none"> <li>Check the water supply line to the dispenser is blocked, open the water tap completely.</li> <li>Tap on the "Active Failures List" in the programming home menu and then tap on the "Reset Failures" icon. Contact service if the error remains.</li> </ul>
Err 30/31	Cooling error	<ul style="list-style-type: none"> <li>Check the ventilation and the ambient temperature of the dispenser, and clean the condensate grid, if necessary.</li> <li>Tap on the "Active Failures List" in the programming home menu and then tap on the "Reset Failures" icon. Contact service if the error remains.</li> </ul>
Err 60/61/63	Mixing bowl(s) not detected	<ul style="list-style-type: none"> <li>Check if both mixing bowls are correctly in place. Contact service if the error remains.</li> </ul>
Water leaks from the hot water outlet or a product outlet.	Scale particles block the respective outlet valve, it cannot close completely.	<ul style="list-style-type: none"> <li>Perform the program "Flush", <i>see page 17</i>. Contact service if the problem persists.</li> </ul>
The dispenser does not respond to tapping on the touch screen.	A software jam has occurred.	<ul style="list-style-type: none"> <li>Reset the dispenser: Disconnect the power supply and connect again after 5 seconds. Contact service if the problem persists.</li> </ul>



# 9 - SPECIFICATIONS

Versions*	Milk-Coffee	Coffee-Coffee
Dimensions		
	Height	Door closed: 692 mm / 27.24 in (Door open: 920 mm / 36.2 in)
	Width	380 mm / 14.96 in
	Depth	524 mm / 20.63 in
Weight		
	empty	38.5 kg / 86 lbs
	filled	49 kg / 108 lbs
Maximum cup/pot height		
	Cups:	157 mm / 6.2 in
	Pots:	157 mm / 6.2 in (with drip tray) 207 mm / 8.2 in (without drip tray or when using the <i>optional</i> pot extension)
Ingredient capacity		2 disposable Bag-in-Box (BIB) ingredient packs with a capacity of: 2 liter / 0.53 gal (coffee and milk), or 1.25 liter / 0.33 gal (coffee), or 0.75 liter / 0.20 gal (milk)
Drink capacity		300 cups at 100 ml / 3.3 fl. oz. per hour at 3.3 kW (230V)
Boiler capacity		6 liter / 1.58 gal

\* = some versions might not be available in all markets

Standard water connection	1/2" or 3/8" supply line with 3/4" BSP connecting piece Drinking water line with stop valve Max. water inlet temperature 60°C / 140°F								
Dynamic pressure	Min. 0.8 bar at 10 l/min - 11 psi at 2.6 gal/min								
Static pressure	Max. 10 bar - 140 psi								
Hot water connection	Via copper pipes only								
Connection water cooling unit	Dynamic pressure: min. 0.8 bar at 1.2 l/min - 11 psi at 0.7 gal/min								
Refrigerant	0.035 kg of R134a								
Electrical specification	<ul style="list-style-type: none"> <li>• By power cord and plug 1.80 m / 70.9 in</li> <li>• Direct power connection according to the Safety Instructions</li> </ul> <p>For the connected loads refer to the rating plate.</p> <table> <tr> <td>1-phase operation Europe:</td> <td>max. 3.3 kW at 230-240 VAC (16A)</td> </tr> <tr> <td>3-phase operation Europe:</td> <td>max. 8.9 kW at 400 VAC (3×16A)</td> </tr> <tr> <td>1-phase operation North America:</td> <td>max. 1.4 kW at 120 VAC (20A)</td> </tr> <tr> <td>2-phase operation North America:</td> <td>max. 9.0 kW at 120/240 VAC (50A)</td> </tr> </table>	1-phase operation Europe:	max. 3.3 kW at 230-240 VAC (16A)	3-phase operation Europe:	max. 8.9 kW at 400 VAC (3×16A)	1-phase operation North America:	max. 1.4 kW at 120 VAC (20A)	2-phase operation North America:	max. 9.0 kW at 120/240 VAC (50A)
1-phase operation Europe:	max. 3.3 kW at 230-240 VAC (16A)								
3-phase operation Europe:	max. 8.9 kW at 400 VAC (3×16A)								
1-phase operation North America:	max. 1.4 kW at 120 VAC (20A)								
2-phase operation North America:	max. 9.0 kW at 120/240 VAC (50A)								
Environmental specifications									
Acoustic Emission	The A-weighted sound pressure level of the dispenser is below 48 dB.								
Ambient Temperature for installation & operation	Between 5°C / 41°F and 32°C / 90°F								
Compliance	VDE, CE (2006/42/EC machinery directive, 2004/108/EC EMC directive, 2002/72/EC food safety) NSF (Only for Marine Version)								

*The manufacturer reserves the right to change specifications without prior notice.*

# APPENDIX A - INTERNATIONAL LISTING OF POWER PLUGS

Country	Plug type	Manufacturer/ trademark	Type/model	Technical data	Standard	Mark(s) of conformity
UK	Type G	Patelec Elpena/Ningbo	MUK	3G0,75/1/1,5	BS 1363-1	BSI/HAR
Japan	Type B	Patelec Ningbo	42	3x0,75/1,25/2	JIS C8303, JIS C8306	PSE/JET
Australia	Type I	Patelec Elpena/Ningbo	161-165	3G0,75/1/1,5	AS/NZS 3112	NSW GOVERNMENT
South Korea	Type C	Patelec Ningbo	152 KOREA	2x0,75/1/1,5	K60884-1, KSC 8305	Korea Testing laboratory
	Type F	Patelec Ningbo	232 KOREA	3G0,75/1/1,5	K60884-1, KSC 8305	Korea Testing laboratory
Singapore	Type G	Patelec Ningbo	MUK	3G0,75/1/1,5	SS 145:part 1:2010	COC
Saudi Arabia	Type G	Patelec Ningbo	MUK	3G0,75/1/1,5	BD14004	GULF TYPE EXAMINATION CERTIFICATE
South Africa	Type M	Patelec Elpena	507	3G0,75/1/1,5	SANS 164-1	SABS
UAE	Type G	Patelec Ningbo	MUK	3G0,75/1/1,5	BD14004	GULF TYPE EXAMINATION CERTIFICATE
Qatar	Type G	Patelec Ningbo	MUK	3G0,75/1/1,5	BD14004	GULF TYPE EXAMINATION CERTIFICATE
Russia	Type C					
	Type F					
Egypt	Type C					
	Type F					
Thailand	Type A					
	Type B					
	Type C					
	Type F					